



OrbiCult™ Ambient Shaker  
Model AS1-NC-19



OrbiCult™ Incubator Benchtop Shaker  
Model IBS-R-19-1

# OrbiCult™ Shakers

Exceptional Choice for Versatile and Reliable Shaking Application



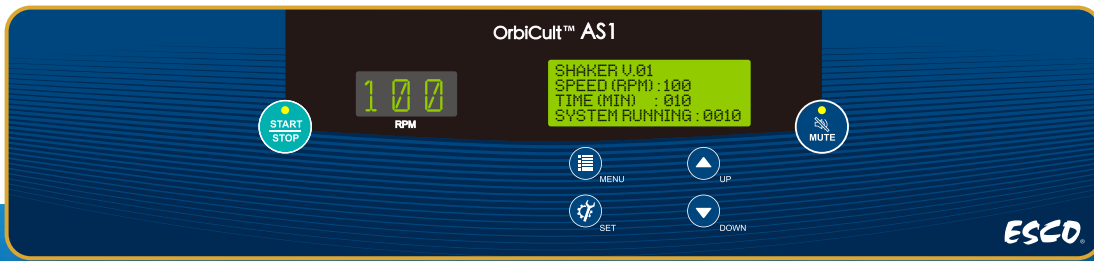

## Alarm System

- Produces 5 audible alarm on each end-run
- Speed deviation alarm

## Digital LED

- Displays all information simultaneously on the screen
- Easy-to-use design which enables to set precise parameter
- Audible and visible alarm alert any undesirable situation
- Automatically restart after power interruption for the non-volatile program saved in the memory

## SmartRun™: Imbalance Compensation Algorithm

- Excellent out-of-balance sensor and propriety imbalance compensation algorithm adjust the optimum rpm to ensure smooth operation without any vibration
- PID (Proportional-Integral-Derivative) Microprocessor for speed control system



## TriDrive™: Triple-Eccentric Counterbalanced Drive System

- Robust triple-eccentric counterbalanced drive supports long service life
- Two types of orbit (19 mm and 25 mm) that meet different applications
- Brushless DC motor provides consistent and no vibration rotation
- Wide Speed Range: 15 - 575 rpm
- Low noise and low heat emission
- Installed with acceleration / deceleration circuit to prevent spillage



## Connecting Alarm Contacts

- Located at the back of the unit to monitor speed, shaker imbalance, and power recovery alarms



OrbiCult™ Ambient Shaker  
Model: AS1-NC-19

## ISOCIDE™ Powder Coat

- Easy-to-clean external surface coated with Isocide™ to eliminate 99.9% of surface bacteria within 24 hours of exposure

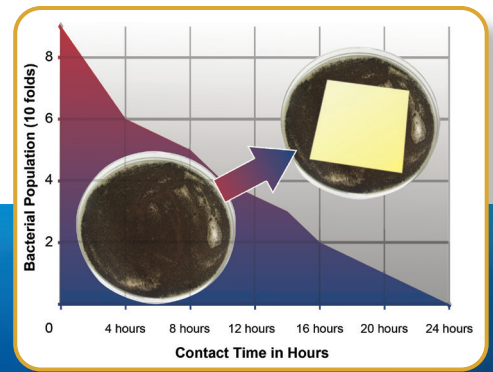

## Large Capacity with Slim Structure

- Maximum capacity of 30 Kg

## CO<sub>2</sub> Resistant Model

- Designed with material resistant components that adapt to CO<sub>2</sub> and humid environment that ensures the AS1 CO<sub>2</sub> resistance model to have a long-term worry-free operation
- Suitable for cell incubation application.

## Leveling Feet

- Built-in leveling feet that can be adjusted to level the unit

## Multiple Interchangeable Platform

- Customizable to accommodate different applications
- Three interchangeable platform sizes are available to minimize footprint
- Has two types of Platform: Universal Platform and Dedicated Platform

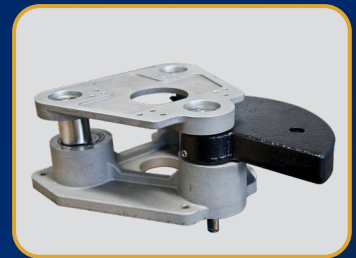

Common Application List of OrbiCult™ Shaker

Cell Culture	Bacterial Suspension
Solubility Testing	Growth of Bacteria and Yeast
Extraction Procedures	Washing Procedures
Diagnostics Tests	Hybridization
General Mixing	Staining and Destaining



## SmartRun™: Imbalance Compensation Algorithm

- Excellent out-of-balance sensor that adjusts the optimum rpm to ensure smooth operation without any vibration

## SmarTouch™: Large 5.7" intuitive touchscreen displays every parameter and status of your shaker at a glance

- Easy-to-use design enables to set parameter precisely
- Historical setting can easily track and review from the touchscreen

## Alarm System

- Produces 5 audible alarm on each end-run
- Speed deviation alarm
- High and low temperature alarm from the set point
- Unbalanced load on shaker platform
- Audible alarm can be turned on or off, however the visual alarm will still remain activated even when the audible alarm is off



## Transparent Acrylic Hood

- Durable and only half as heavy as glass
- Clear cover allows easy viewing of samples
- Door sensor pauses the driver rotation when the chamber door is open

## TriDrive™: Triple-Eccentric Counterbalanced Drive System

- Robust triple eccentric counterbalanced drive supports long service life
- Two types of orbit (19 mm and 25 mm) that meet different applications
- Brushless DC motor provides consistent and no vibration rotation
- Wide Speed Range: 15 - 575 rpm
- Low noise and low heat emission
- Installed with acceleration/deceleration circuit to prevent spillage

## Large Capacity with Slim Structure

- Maximum capacity of 30 Kg

## Leveling Feet

- Built-in leveling feet that can be adjusted to level the unit



OrbiCult™ Incubator Benchtop Shaker  
Model: IBS-R-19-3

## Precise and Wide Temperature Range

- Refrigerated: 10°C below ambient to 80°C
- Non-refrigerated: 5°C above ambient to 80°C
- Built with forced convection ventilation to ensure accurate temperature avoiding possible deviations during the operation
- Environment-friendly design
- World-class compressor with low energy consumption
- Temperature sensor stops the heater or compressor in any exceeded temperature



### Access Port

- Ergonomic design that gives easy access for temperature validation and mapping



### Environment-Friendly Refrigeration System

- Uses CFC-free refrigerant, good for the environment

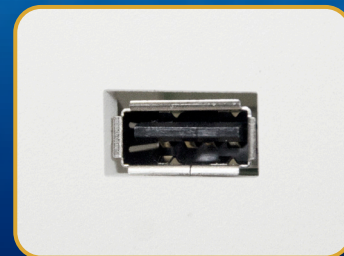

### USB Port

- Easy access to transport data log and alarm log to an external hard disk



### Gas Manifold Port

- Add versatility for aerobic and anaerobic cultivation
- Available with a 12-port gas manifold option
- Allows the operator to supply gas directly to the culture medium of 12 individual flasks



### Connecting Alarm Contacts

- Located at the back of the unit to monitor speed, shaker imbalance, and power recovery alarms

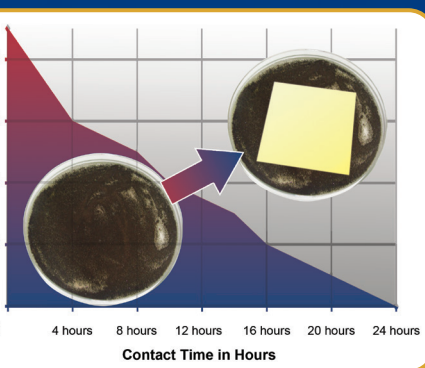

### Medium-sized Platform

- Suitable platform is available to maximize the area inside the chamber
- Has two types of Platform: Universal Platform and Dedicated Platform

### ISOCIDE™ Powder Coat

- Easy-to-clean external surface coated with Isocide™ to eliminate 99.9% of surface bacteria within 24 hours of exposure

Common Application List of Orbicult™ Incubator Benchtop Shaker	
Cell Culture	Bacterial Suspension
Solubility Studies	Growth of Bacteria and Yeast
Extraction Procedures	Washing Procedures
Diagnostics Tests	Hybridization
General Mixing	Staining and Destaining

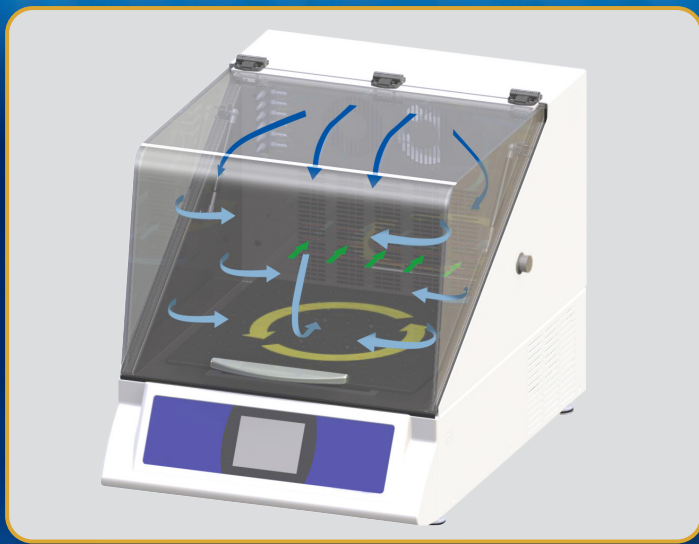

## Airflow Circulation

- Two circulating fans located on top of the perforated panel disperse and distribute the air inside the chamber
- Perforation located below the circulating fan absorbs the air to recirculate the air inside the chamber
- Platform performs counterclockwise rotation based on the motor drive motion
- Air temperature changes during suction process
  - For refrigerated unit, the evaporator located behind the perforated panel will cool down the air
  - For non-refrigerated unit, a heater located below the circulating fan will heat up the air

## Digital LED Controller (for AS1 model)

Displays the status of speed at which the shaker is currently rotating

A graphical interface indicates shaker performance through an alphanumeric display. It presents the status of rpm, time and system running that are activated by programming access through the membrane buttons

Deactivates the set alarm during the end of a timed run and deviations on speed and temperature setpoint

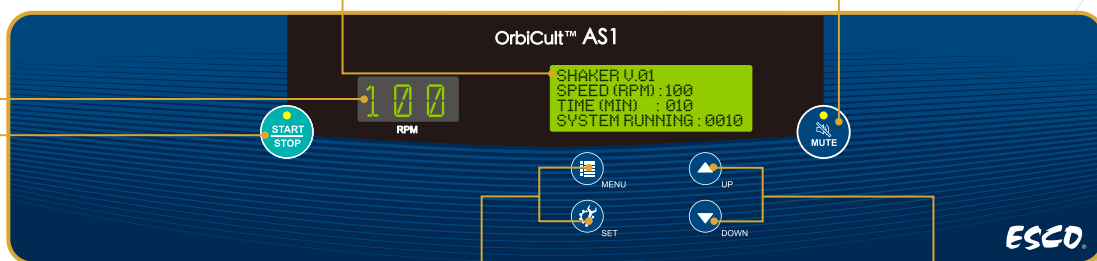

6

The Shaker LED light displays green to indicate that the shaker is operational accessible

These keypad buttons control the settings and program system running as required for the application. Gives access to default settings and classified menus

Allows navigation and set up the desired program with accuracy and precision

## SmarTouch™ Controller (for IBS model)

An advanced and intuitive touchscreen that provides clear and accurate conditions of the operation to keep track of the performance of each feature and functions set on the program

Status Indicator:

Displays the basic yet important parameters and factors of a program. It shows careful conditions of the program for an accessible observation of the operation (i.e. lid closure, running program, and temperature)



**Home Button:**  
Provides major icons for easy navigation on important functions

**Menu Button:**  
Access specific features for setting desired program

**Diagnostic Screen:**  
Provides readout of current system parameters, date and stamp of all historical alarm, and graph datalog

**Shaker Platform Button:**  
Access to start / stop the platform

**Alarm Button:**  
An option to the alarm function to make it audible or mute

**Help Button:**  
Explains the icons displayed on the screen interface

## OrbiCult™ Ambient Shaker Models (AS1-C-19, AS1-C-25, AS1-NC-19, AS1-NC-25)

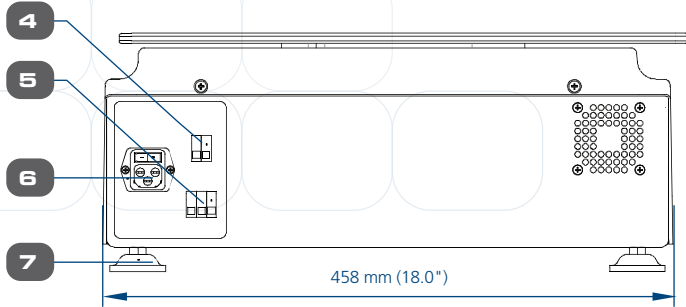
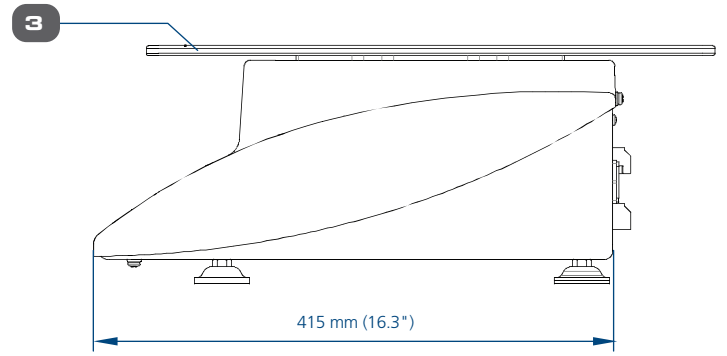
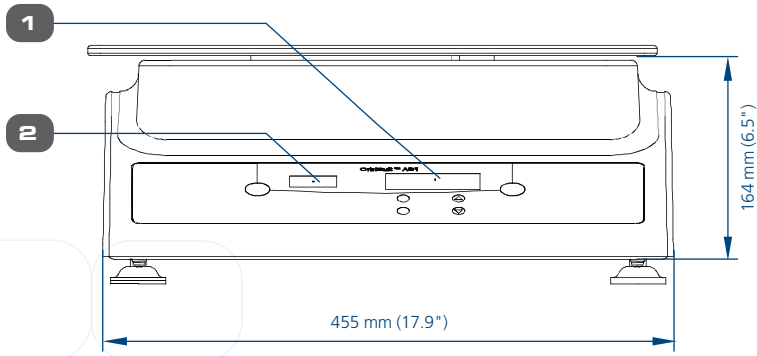

- 1. Control Display
- 2. Rpm Display
- 3. Platform (Interchangeable)
- 4. Analog Output
- 5. Alarm Contact
- 6. Power Plug
- 7. Leveling Feet

## OrbiCult™ Incubator Benchtop Shaker Models (IBS-R-19-\_, IBS-R-25-\_, IBS-NR-19-\_, IBS-NR-25-\_)

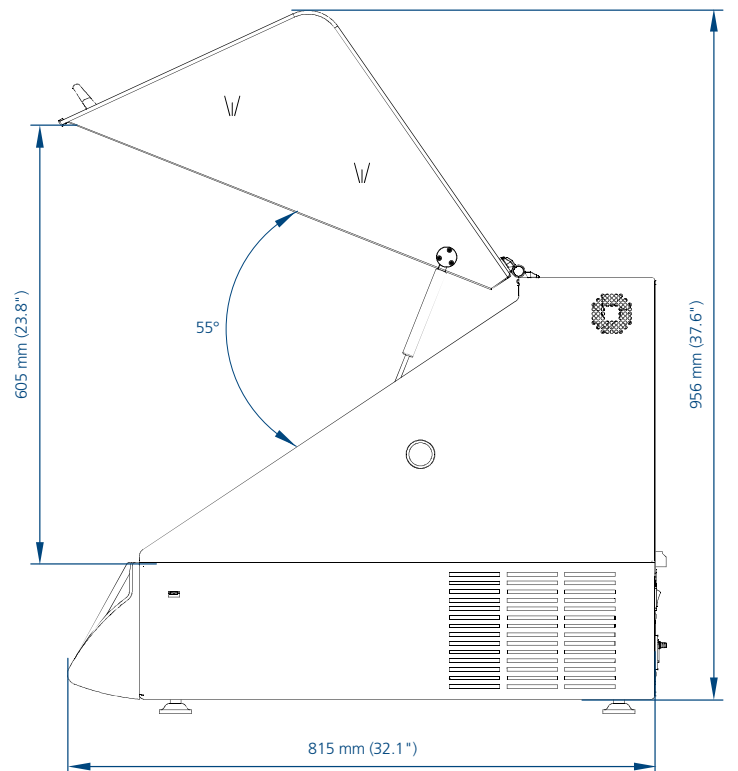
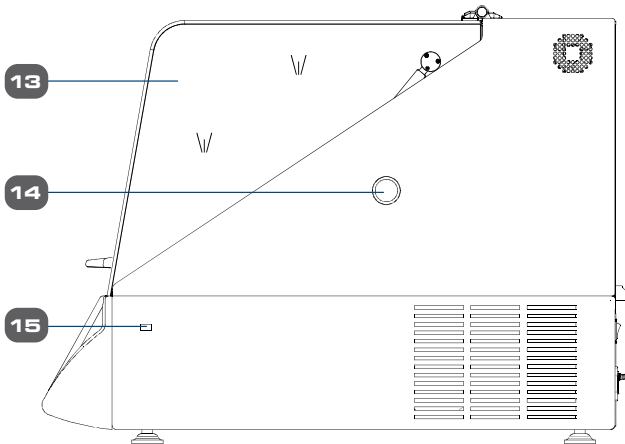
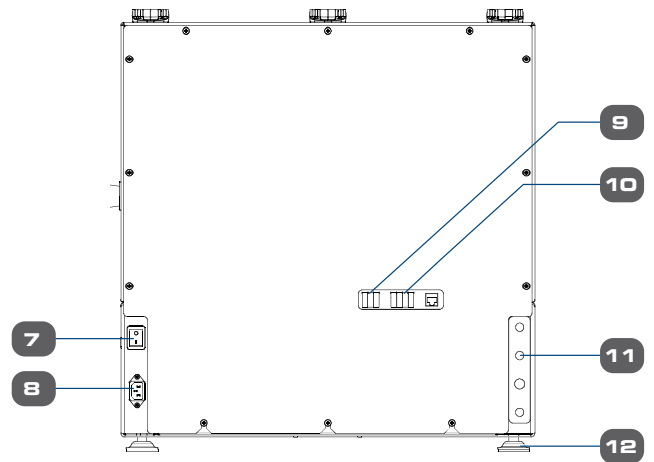
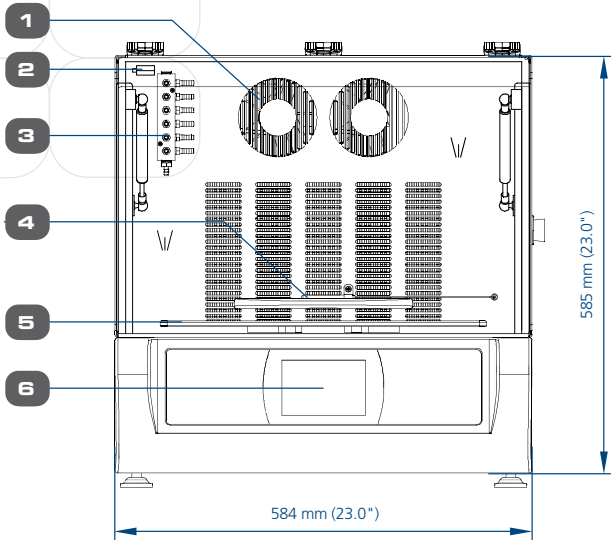

- 1. Circulation Fan
- 2. Door Switch
- 3. Gas Manifold
- 4. Temperature Sensor
- 5. Platform
- 6. Touchscreen Control
- 7. On / Off Switch
- 8. Power Plug
- 9. Alarm Contact
- 10. Analog Output
- 11. Gas Inlet Filling
- 12. Leveling Feet
- 13. Transparent Acrylic Hood
- 14. Access Port
- 15. USB Port

## TECHNICAL SPECIFICATION

Model	AS1 -C-19 2200002	AS1 -C-25 2200004	AS1 -NC-19 2200001	AS1 -NC-25 2200003	IBS -NR-19-8 2200009	IBS -NR-25-8 2200011	IBS -NR-19-9 2200010	IBS -NR-25-9 2200012	IBS -R-19-1 2200005	IBS -R-25-1 2200007	IBS -R-19-2 2200006	IBS -R-25-2 2200008	IBS -R-19-3 2200015	IBS -R-25-3 2200016	
Electrical Supply	100 - 240 VAC, 50 / 60 Hz				230 VAC, 50 / 60 Hz		115 VAC, 50 / 60 Hz		230 VAC, 50 Hz		115 VAC, 60 Hz		230 VAC, 60 Hz		
Orbit Size	19 mm (0.7")	25 mm (1.0")	19 mm (0.7")	25 mm (1.0")	19 mm (0.7")	25 mm (1.0")	19 mm (0.7")	25 mm (1.0")	19 mm (0.7")	25 mm (1.0")	19 mm (0.7")	25 mm (1.0")	19 mm (0.7")	25 mm (1.0")	
Speed Range	15 - 575 rpm														
rpm Accuracy	+ / - 1														
Display	Digital LED and 4 line LCD message center				Colored Touchscreen										
Timer	9999 minutes				999 hrs and 59 minutes										
Maximum Load	30 Kg (66.1 lbs)	25 Kg (55.1 lbs)	30 Kg (66.1 lbs)	25 Kg (55.1 lbs)	30 Kg (66.1 lbs)	25 Kg (55.1 lbs)	30 Kg (66.1 lbs)	25 Kg (55.1 lbs)	30 Kg (66.1 lbs)	25 Kg (55.1 lbs)	30 Kg (66.1 lbs)	25 Kg (55.1 lbs)	30 Kg (66.1 lbs)	25 Kg (55.1 lbs)	
External Dimension (W x D x H)	455 x 415 x 164 mm (17.9" x 16.3" x 6.5")				584 x 815 x 585 mm (23.0" x 32.1" x 23.0")										
Internal Dimension (W x D x H)					535 mm X 466 mm X 366 mm (21.1" x 18.3" x 14.4")										
Internal Volume					99.3 L										
Net Weight	23 Kg (50.7 lbs)		27 Kg (59.5 lbs)		70 Kg (154.3 lbs)				80 Kg (176.4 lbs)						
CO <sub>2</sub> Resistant	Yes		No												
External Cover Material	UL 94 Flammability Standard, V-0 requirement made of ABS Plastic														
Platform Material	Anodized Aluminum														
Cabinet Construction	Base	3.0 mm (0.1") 18 gauge EG Steel with Isocide™ Anti-microbial Powder Coating													
	Main	2.0 mm (0.08") 18 gauge EG Steel with Isocide™ Anti-microbial Powder Coating													
	Work zone	2.0 mm (0.08") 16 gauge Stainless Steel													
Temperature Range					5 °C (above ambient) - 80°C				10°C (below ambient) - 80°C						
Temperature Accuracy					± 0.5										
Access Port					30 mm (1.2")										
Shipping Weight	33 Kg (72.8 lbs)		37 Kg (81.6 lbs)		90 Kg (198.4 lbs)				100 Kg (220.5 lbs)						
Shipping Dimension (W x D x H)	650 mm x 650 mm x 460 mm (25.6" x 25.6" x 18.1")				720 x 1120 x 860 mm (28.3" x 44.1" x 33.9")										
Shipping Volume, Maximum	0.2 m <sup>3</sup> (7.1 ft <sup>3</sup> )				0.7 m <sup>3</sup> (24.7 ft <sup>3</sup> )										

## Ordering Information

Accessories	Item Code	Item Name	Description	25 mL Flask	50 mL Flask	125 mL Flask	250 mL Flask	300 mL Flask	500 mL Flask	1 L Flask	2 L Flask	2.8 L Flask	3 L Flask	4 L Flask	5 L Flask	6 L Flask
Platform List (Universal)	5270016	Small Universal	330 x 330 mm (13.0" x 13.0")	36	36	13	9	9	9	4	4	1	1	1	1	1
	5270017	Medium Universal	457 x 457 mm (18.0" x 18.0")	64	64	32	16	16	16	8	5	4	4	4	4	2
	5270018	Large Universal	457 x 610 mm (18.0" x 24.0")		70	35	20	20	20	12	8	5	5	5	4	3

Note:  
 Universal Platform Medium for IBS only allows until 2.8L flask.  
 The platform is not included with the shaker and must be ordered separately.

**OrbiCult™**

AS1 and IBS • Laboratory Shakers



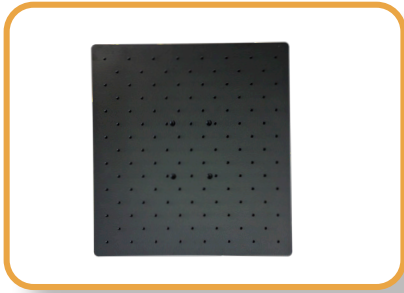

### Universal Platform

Have standard holes pattern that can fit any flask clamps and test tube rack. All multiple flask clamps and labware holders are shipped separately and installed by the end-user.



### Dedicated Platform

Platforms have a customized pattern to optimize the number of a particular size of flask clamp on a platform. Dedicated platforms are pre-installed with the flask clamps.



### Flask Clamps

Single-piece stainless steel clamps that provide enough strength and security to hold flasks.



### Test Tube Rack

Stainless steel rack that stabilizes and holds the test tubes.

*Note: The test tube rack comes in two colors (white and black) and is subject to availability.*

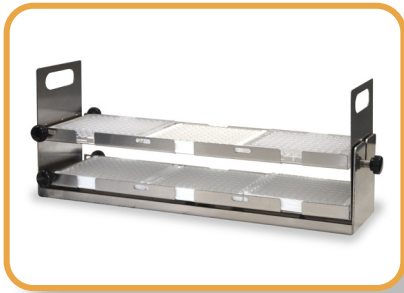

### Microplate Holder

Double layer racks that hold up to six standard deep well plates.



### Utility Carrier

Made of stainless steel that holds different glassware in between adjustable stainless steel bars.

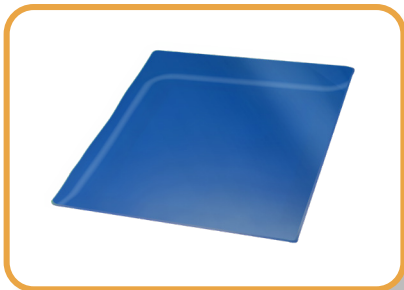

### Sticky Mats

Allows the user to place the flask directly on the mat without the use of a clamp. Sticky mats are very convenient if the user desires to rotate at less than 350 rpm. This can be ordered separately and attach on Universal Platform.



### Gas Manifold

Contain 12 gas ports that add versatility for aerobic and anaerobic cell cultivation. The IBS is available with a 12-port gas manifold option to allow the operator to supply gas directly to the culture medium of 12 individual flasks.

## Accessories

Model Code	Item Code	AS1-C-19	AS1-C-25	AS1-NC-19	AS1-NC-25	Flask Clamp Quantity
PU-S	5270016	Platform, Universal, Small - 330 X 330 mm (13.0" X 13.0")				
PU-M	5270017	Platform, Universal, Medium - 457 x 457 mm (18.0" x 18.0")				
PU-L	5270018	Platform, Universal, Large - 457 x 610 mm (18.0" x 24.0")				
PD-S-25	5270019	Platform, Dedicated, Small, for 25 ml Flask, 330 x 330 mm (13.0" x 13.0")				36
PD-S-50	5270020	Platform, Dedicated, Small, for 50 ml Flask 330 x 330 mm (13.0" x 13.0")				36
PD-S-125	5270021	Platform, Dedicated, Small, for 125 ml Flask 330 x 330 mm (13.0" x 13.0")				16
PD-S-250	5270022	Platform, Dedicated, Small, for 250 ml Flask 330 x 330 mm (13.0" x 13.0")				10
PD-S-300	5270023	Platform, Dedicated, Small, for 300 ml Flask 330 x 330 mm (13.0" x 13.0")				10
PD-S-500	5270024	Platform, Dedicated, Small, for 500 ml Flask 330 x 330 mm (13.0" x 13.0")				9
PD-S-1L	5270025	Platform, Dedicated, Small, for 1 L Flask 330 x 330 mm (13.0" x 13.0")				5
PD-S-2L	5270026	Platform, Dedicated, Small, for 2 L Flask 330 x 330 mm (13.0" x 13.0")				4
PD-S-2.8L	5270027	Platform, Dedicated, Small, for 2.8 L Flask 330 x 330 mm (13.0" x 13.0")				1
PD-S-3L	5270028	Platform, Dedicated, Small, for 3 L Flask 330 x 330 mm (13.0" x 13.0")				1
PD-S-4L	5270029	Platform, Dedicated, Small, for 4 L Flask 330 x 330 mm (13.0" x 13.0")				1
PD-S-5L	5270030	Platform, Dedicated, Small, for 5 L Flask 330 x 330 mm (13.0" x 13.0")				1
PD-S-6L	5270031	Platform, Dedicated, Small, for 6L Flask 330 x 330 mm (13.0" x 13.0")				1
PD-M-25	5270032	Platform, Dedicated, Medium, for 25 ml Flask 457 x 457 mm (18.0" x 18.0")				64
PD-M-50	5270033	Platform, Dedicated, Medium, for 50 ml Flask 457 x 457 mm (18.0" x 18.0")				64
PD-M-125	5270034	Platform, Dedicated, Medium, for 125 ml Flask 457 x 457 mm (18.0" x 18.0")				36
PD-M-250	5270035	Platform, Dedicated, Medium, for 250 ml Flask 457 x 457 mm (18.0" x 18.0")				25
PD-M-300	5270036	Platform, Dedicated, Medium, for 300 ml Flask 457 x 457 mm (18.0" x 18.0")				25
PD-M-500	5270037	Platform, Dedicated, Medium, for 500 ml Flask 457 x 457 mm (18.0" x 18.0")				16
PD-M-1L	5270038	Platform, Dedicated, Medium, for 1 L Flask 457 x 457 mm (18.0" x 18.0")				9
PD-M-2L	5270039	Platform, Dedicated, Medium, for 2 L Flask 457 x 457 mm (18.0" x 18.0")				5
PD-M-2.8L	5270040	Platform, Dedicated, Medium, for 2.8 L Flask 457 x 457 mm (18.0" x 18.0")				4
PD-M-3L	5270041	Platform, Dedicated, Medium, for 3 L Flask 457 x 457 mm (18.0" x 18.0")				4
PD-M-4L	5270042	Platform, Dedicated, Medium, for 4 L Flask 457 x 457 mm (18.0" x 18.0")				4
PD-M-5L	5270043	Platform, Dedicated, Medium, for 5 L Flask 457 x 457 mm (18.0" x 18.0")				4
PD-M-6L	5270044	Platform, Dedicated, Medium, for 6 L Flask 457 x 457 mm (18.0" x 18.0")				2
PD-L-50	5270046	Platform, Dedicated, Large, for 50 ml Flask 457 x 610 mm (18.0" x 24.0")				80
PD-L-125	5270047	Platform, Dedicated, Large, for 125 ml Flask 457 x 610 mm (18.0" x 24.0")				48
PD-L-250	5270048	Platform, Dedicated, Large, for 250 ml Flask 457 x 610 mm (18.0" x 24.0")				35
PD-L-300	5270049	Platform, Dedicated, Large, for 300 ml Flask 457 x 610 mm (18.0" x 24.0")				35
PD-L-500	5270050	Platform, Dedicated, Large, for 500 ml Flask 457 x 610 mm (18.0" x 24.0")				20
PD-L-1L	5270051	Platform, Dedicated, Large, for 1 L Flask 457 x 610 mm (18.0" x 24.0")				12
PD-L-2L	5270052	Platform, Dedicated, Large, for 2 L Flask 457 x 610 mm (18.0" x 24.0")				8
PD-L-2.8L	5270053	Platform, Dedicated, Large, for 2.8 L Flask 457 x 610 mm (18.0" x 24.0")				5
PD-L-3L	5270054	Platform, Dedicated, Large, for 3 L Flask 457 x 610 mm (18.0" x 24.0")				5
PD-L-4L	5270055	Platform, Dedicated, Large, for 4 L Flask 457 x 610 mm (18.0" x 24.0")				5
PD-L-5L	5270056	Platform, Dedicated, Large, for 5 L Flask 457 x 610 mm (18.0" x 24.0")				4
PD-L-6L	5270057	Platform, Dedicated, Large, for 6 L Flask 457 x 610 mm (18.0" x 24.0")				4

### Accessories

Model Code	Item Code	AS1-C-19	AS1-C-25	AS1-NC-19	AS1-NC-25	Tubes per Rack
TR-S-1	5270072	Test Tube Rack Small 8-11 mm				40
TR-S-2	5270073	Test Tube Rack Small 12-15 mm				21
TR-S-3	5270074	Test Tube Rack Small 16-19 mm				10
TR-S-4	5270075	Test Tube Rack Small 20-22 mm				10
TR-S-5	5270076	Test Tube Rack Small 23-26 mm				5
TR-S-6	5270077	Test Tube Rack Small 27-33 mm				5
TR-M-1	5270078	Test Tube Rack Medium 8-11 mm				64
TR-M-2	5270079	Test Tube Rack Medium 12-15 mm				33
TR-M-3	5270080	Test Tube Rack Medium 16-19 mm				18
TR-M-4	5270081	Test Tube Rack Medium 20-22 mm				16
TR-M-5	5270082	Test Tube Rack Medium 23-26 mm				8
TR-M-6	5270083	Test Tube Rack Medium 27-33 mm				8
TR-L-1	5270002	Test Tube Rack Large 8-11 mm				88
TR-L-2	5270003	Test Tube Rack Large 12-15 mm				48
TR-L-3	5270004	Test Tube Rack Large 16-19 mm				24
TR-L-4	5270005	Test Tube Rack Large 20-22 mm				22
TR-L-5	5270006	Test Tube Rack Large 23-26 mm				11
TR-L-6	5270007	Test Tube Rack Large 27-33 mm				11

### Options and Accessories

Model Code	Item Code	AS1-C-19	AS1-C-25	AS1-NC-19	AS1-NC-25
FC-25	5270059	Flask Clamp 25 ml			
FC-50	5270060	Flask Clamp 50 ml			
FC-125	5270061	Flask Clamp 125 ml			
FC-250	5270062	Flask Clamp 250 ml			
FC-300	5270063	Flask Clamp 300 ml			
FC-500	5270064	Flask Clamp 500 ml			
FC-1L	5270065	Flask Clamp 1 L			
FC-2L	5270066	Flask Clamp 2 L			
FC-2.8L	5270067	Flask Clamp 2.8 L			
FC-3L	5270068	Flask Clamp 3 L			
FC-4L	5270069	Flask Clamp 4 L			
FC-5L	5270070	Flask Clamp 5 L			
FC-6L	5270071	Flask Clamp 6 L			
MH-L	5270008	Microplate holder - Large			
MH-M	5270009	Microplate holder - Medium			
MH-S	5270010	Microplate holder - Small			
UC-S	5270011	Utility Carrier, Small, 332 x 77 x 304 mm (13" x 3" x 12")			
UC-M	5270012	Utility Carrier, Medium, 462 x 77 x 431 mm (18" x 3" x 17")			
AMP	5270014	Adhesive Mat Platform (200 x 200 x 3 mm)			

Accessories						
Model Code	Item Code	IBS-NR-19	IBS-NR-25	IBS-R-19	IBS-R-25	Flask Clamp Quantity
PU-M	5270017	Platform, Universal, Medium - 457 x 457 mm (18.0" x 18.0")				
PD-M-25	5270032	Platform, Dedicated, Medium, for 25 ml Flask 457 x 457 mm (18.0" x 18.0")				64
PD-M-50	5270033	Platform, Dedicated, Medium, for 50 ml Flask 457 x 457 mm (18.0" x 18.0")				64
PD-M-125	5270034	Platform, Dedicated, Medium, for 125 ml Flask 457 x 457 mm (18.0" x 18.0")				36
PD-M-250	5270035	Platform, Dedicated, Medium, for 250 ml Flask 457 x 457 mm (18.0" x 18.0")				25
PD-M-300	5270036	Platform, Dedicated, Medium, for 300 ml Flask 457 x 457 mm (18.0" x 18.0")				25
PD-M-500	5270037	Platform, Dedicated, Medium, for 500 ml Flask 457 x 457 mm (18.0" x 18.0")				16
PD-M-1L	5270038	Platform, Dedicated, Medium, for 1 L Flask 457 x 457 mm (18.0" x 18.0")				9
PD-M-2L	5270039	Platform, Dedicated, Medium, for 2 L Flask 457 x 457 mm (18.0" x 18.0")				5
PD-M-2.8L	5270040	Platform, Dedicated, Medium, for 2.8 L Flask 457 x 457 mm (18.0" x 18.0")				4

Options and Accessories						
Model Code	Item Code	IBS-NR-19	IBS-NR-25	IBS-R-19	IBS-R-25	Tubes per Rack
TR-S-1	5270072	Test Tube Rack Small 8-11 mm				40
TR-S-2	5270073	Test Tube Rack Small 12-15 mm				21
TR-S-3	5270074	Test Tube Rack Small 16-19 mm				10
TR-S-4	5270075	Test Tube Rack Small 20-22 mm				10
TR-S-5	5270076	Test Tube Rack Small 23-26 mm				5
TR-S-6	5270077	Test Tube Rack Small 27-33 mm				5
TR-M-1	5270078	Test Tube Rack Medium 8-11 mm				64
TR-M-2	5270079	Test Tube Rack Medium 12-15 mm				33
TR-M-3	5270080	Test Tube Rack Medium 16-19 mm				18
TR-M-4	5270081	Test Tube Rack Medium 20-22 mm				16
TR-M-5	5270082	Test Tube Rack Medium 23-26 mm				8
TR-M-6	5270083	Test Tube Rack Medium 27-33 mm				8
TR-L-1	5270002	Test Tube Rack Large 8-11 mm				88
TR-L-2	5270003	Test Tube Rack Large 12-15 mm				48
TR-L-3	5270004	Test Tube Rack Large 16-19 mm				24
TR-L-4	5270005	Test Tube Rack Large 20-22 mm				22
TR-L-5	5270006	Test Tube Rack Large 23-26 mm				11
TR-L-6	5270007	Test Tube Rack Large 27-33 mm				11

### Options and Accessories

Model Code	Item Code	IBS-NR-19	IBS-NR-25	IBS-R-19	IBS-R-25
FC-25	5270059			Flask Clamp 25 ml	
FC-50	5270060			Flask Clamp 50 ml	
FC-125	5270061			Flask Clamp 125 ml	
FC-250	5270062			Flask Clamp 250 ml	
FC-300	5270063			Flask Clamp 300 ml	
FC-500	5270064			Flask Clamp 500 ml	
FC-1L	5270065			Flask Clamp 1 L	
FC-2L	5270066			Flask Clamp 2 L	
FC-2.8L	5270067			Flask Clamp 2.8 L	
MH-L	5270008			Microplate holder - Large	
MH-M	5270009			Microplate holder - Medium	
MH-S	5270010			Microplate holder - Small	
UC-S	5270011			Utility Carrier, Small, 332 x 77 x 304 mm (13" x 3"x 12")	
AMP	5270014			Adhesive Mat Platform (200 x 200 x 3 mm)	
GM-12	5270015			12 Port Gas Manifold	

### Guide to Models

**AS 1 - C - 19**

1st Placeholder Product Line	1st Code	2nd Placeholder External Dimension	2nd Code	3rd Placeholder CO <sub>2</sub> Resistance	3rd Code	4th Placeholder Orbit Size	4th Code
Ambient Shaker	<b>AS</b>	455 x 415 x 164 mm (17.9" x 16.3" x 6.5")	1	Resistant	<b>C</b>	19 mm	<b>19</b>
						25 mm	<b>25</b>
				Non-resistant	<b>NC</b>	19 mm	<b>19</b>
						25 mm	<b>25</b>

13

### Guide to Models

**IBS - R - 19 - 1**

1st Placeholder Product Line	1st Code	2nd Placeholder Temperature	2nd Code	3rd Placeholder Orbit Size	3rd Code	4th Placeholder Electrical	4th Code
Incubator Benchtop Shaker	<b>IBS</b>	Refrigerated	<b>R</b>	19 mm	<b>19</b>	220-240 VAC, 50 Hz	<b>1</b>
						110-130 VAC, 60 Hz	<b>2</b>
						230 VAC, 60 Hz	<b>3</b>
				25 mm	<b>25</b>	220-240 VAC, 50 Hz	<b>1</b>
						110-130 VAC, 60 Hz	<b>2</b>
						230 VAC, 60 Hz	<b>3</b>
		Non-refrigerated	<b>NR</b>	19 mm	<b>19</b>	220-240 VAC, 50/60 Hz	<b>8</b>
						110-120 VAC, 50/60 Hz	<b>9</b>
				25 mm	<b>25</b>	220-240 VAC, 50/60 Hz	<b>8</b>
		110-120 VAC, 50/60 Hz	<b>9</b>				

# Load Speed Charts

## OrbiCult™ Ambient Shaker

AS1 Non-CO<sub>2</sub> with 25mm Orbit Shakers

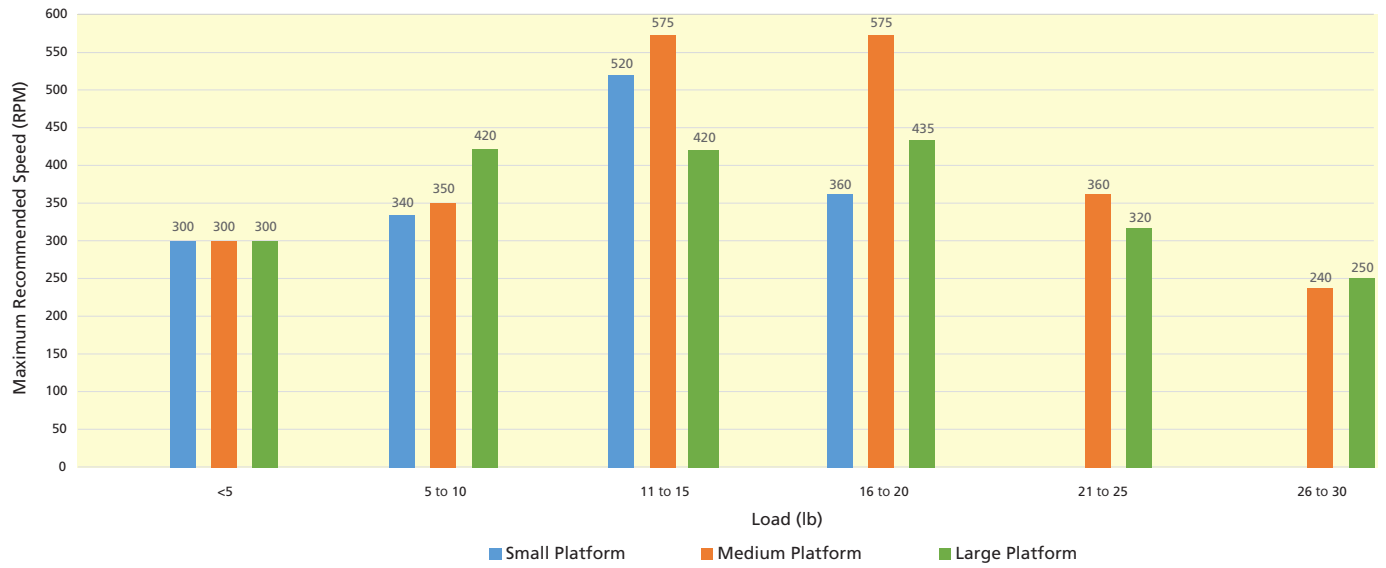

AS1 Non-CO<sub>2</sub> with 19mm Orbit Shakers

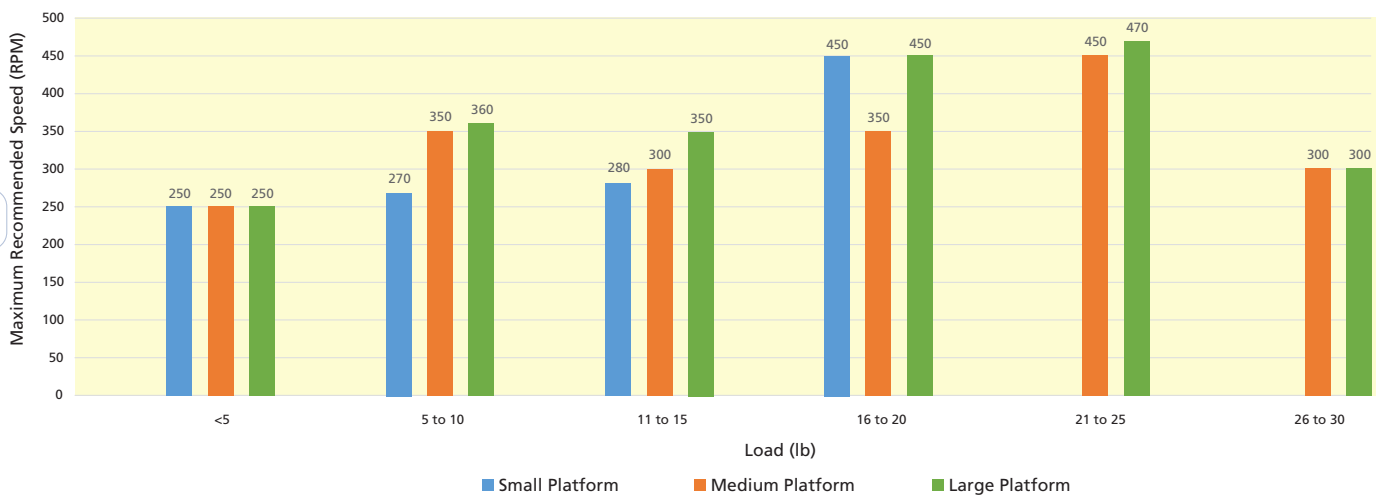

AS1 CO<sub>2</sub> with 25mm Orbit Shakers

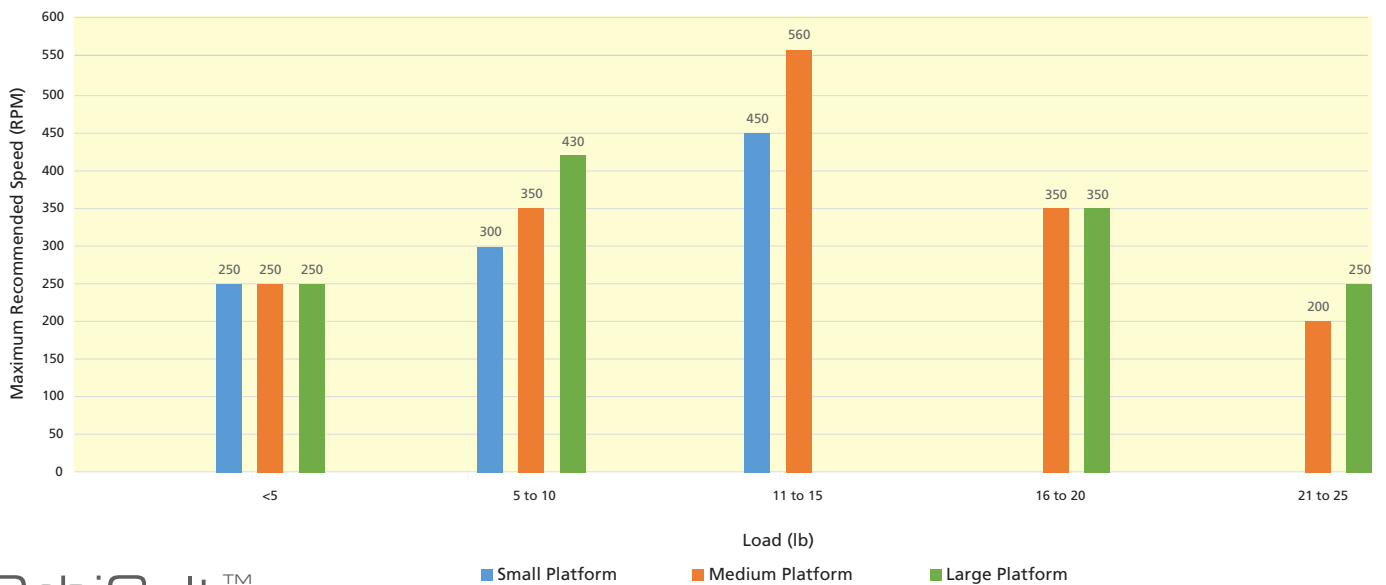

### AS1 CO<sub>2</sub> with 19mm Orbit Shakers

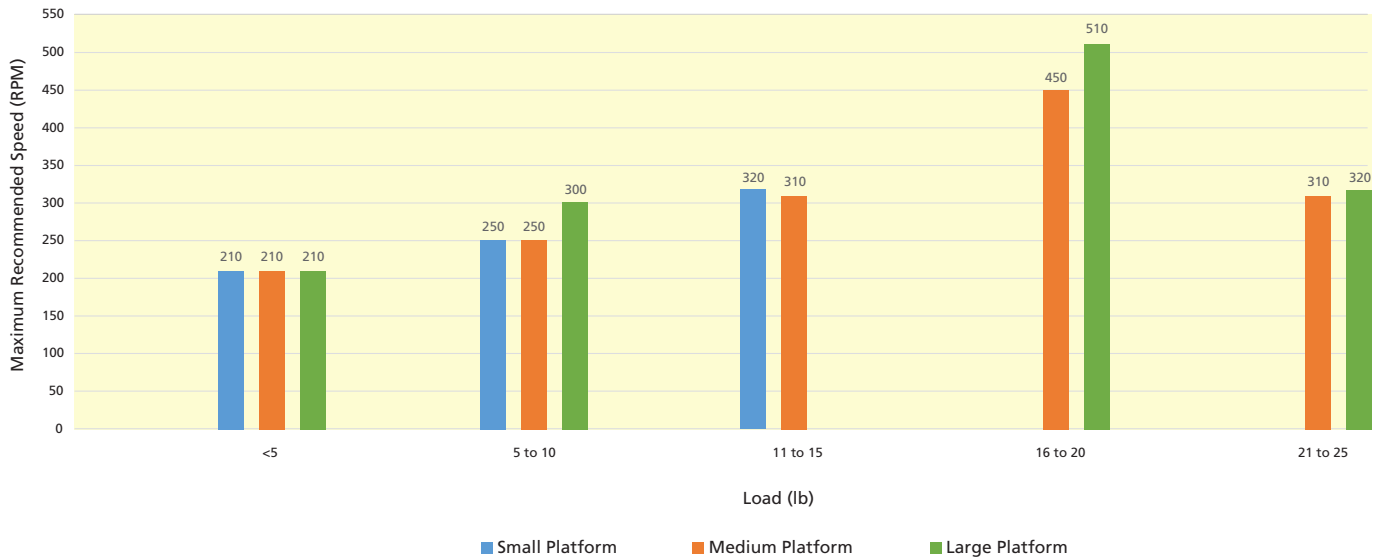

### OrbiCult™ Incubator Benchtop Shaker

#### Refrigerated, 19mm and 25mm Orbit

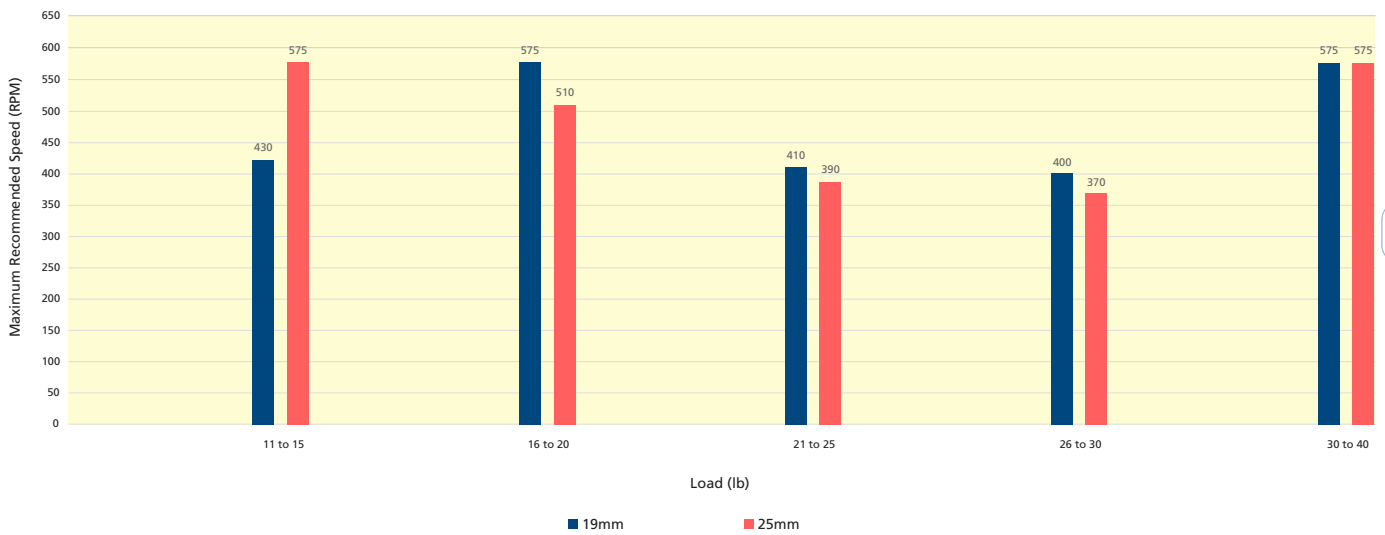

15

#### Non-Refrigerated, 19mm and 25mm Orbit

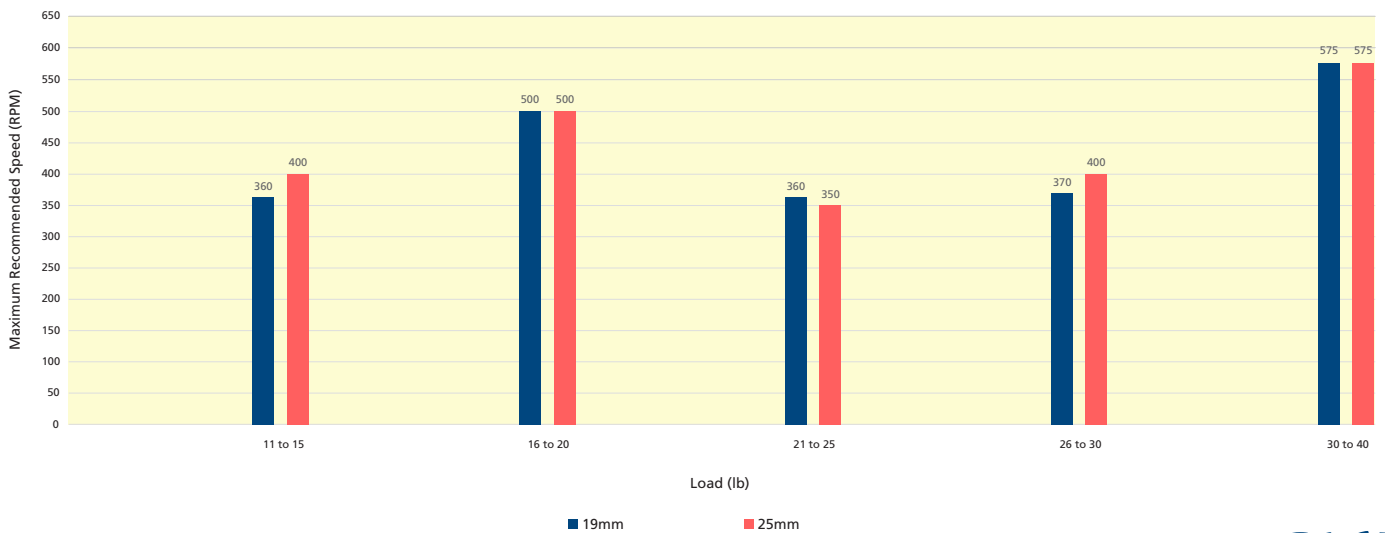

**ESCO LIFESCIENCES GROUP**  
42 LOCATIONS IN 21 COUNTRIES ALL OVER THE WORLD

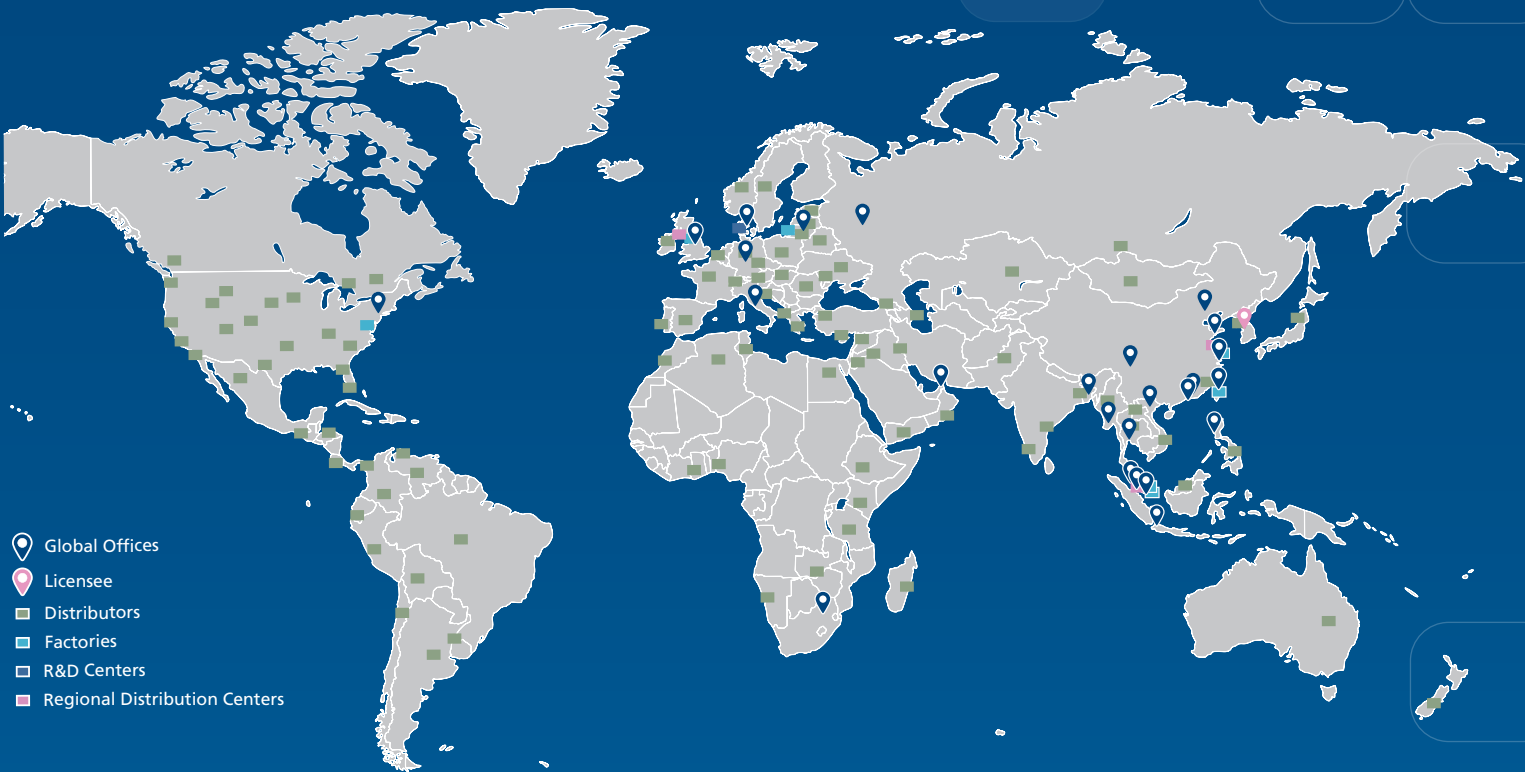

-  Global Offices
-  Licensee
-  Distributors
-  Factories
-  R&D Centers
-  Regional Distribution Centers

*Follow us on social media, download our apps,  
and scan the QR code for more info.*



@EscoLifesciences



@EscoLifesciences



@EscoLifesci



@Esco



@EscoLifesciences



@EscoLifesciences



Esco Lifesciences



Esco Lifesciences

**ESCO**<sup>®</sup>  
LIFESCIENCES GROUP

Esco Micro Pte. Ltd. • 19 Changi South Street 1 • Singapore 486 779  
Tel +65 6542 0833 • mail@escolifesciences.com  
www.escolifesciences.com

Esco Technologies, Inc. • 903 Sheehy Drive, Suite F, Horsham, PA 19044, USA  
Tel: +1 215-441-9661 • eti.admin@escolifesciences.com

**Esco Lifesciences Group Offices:** Bangladesh | China | Denmark | Germany | Hong Kong | India | Indonesia | Italy | Japan | Lithuania | Malaysia | Myanmar | Philippines | Russia | Singapore | South Africa | South Korea | Taiwan | Thailand | UAE | UK | USA | Vietnam